

Product Brochure For T773

Industrial Mobile Tooling Cabinet Workstation - WTC-1450

1170 x 580 x 1450mm
 100kg per Drawer

Ex GST **Inc GST**
\$1,090.00 **\$1,199.00**



ORDER CODE:	T773
MODEL:	WTC-1450
Number of Drawers (No.):	5
Drawer Load Capacity (kg):	100
Maximum Total Load Capacity (kg):	390
Includes Backing Panel:	~
Dimensions (W x D x H) (mm):	1170 x 580 x 1450
Nett Weight (kg):	121



Features

- Heavy duty tooling cabinets, ideal for industrial applications and serious workshops
- Backing panel perfect for optional hooks, prongs & holders
- The sliding drawers are a welded strengthened single rail design coupled with high quality mechanical bearings for long lasting smooth operation
- 5 Drawers, top drawers include a series of different size plastic boxes for those small items, all other drawers come with adjustable steel dividers
- 100kg load capacity per drawer with 97% access
- 250kg load capacity on work bench top
- 390kg total load capacity for mobile work station
- Key lockable drawers & cupboard
- Cupboard consist an adjustable shelf with a load capacity of 40kg
- Powder coated quality finish
- 950mm work bench height
- Portable on caster wheels, 2 with brake
- Includes push handle
- Table Dimensions (W x D x H): 1103 x 580 x 950mm
- Weighs 121kg

Product Brochure For T773

Specific Features



Shown with Optional Tools and Accessories



Front View



Side View



Cupboard with Adjustable Shelf



Top Drawer



2nd Drawer



Bottom Drawers



Key Lockable Drawers



Key Lockable Door



Fixed Wheels



Swivel Wheels



Push Handle



Rubber Matting



Drawer Railings



Drawer Locking Mechanism



Drawers with Safety Locks

Product Brochure For T773



Heavy Duty Drawers



Drawer Lock Bracket



Drawers with Steel Dividers



Top Drawer with Plastic Buckets



Backing Panel Shown with Optional Hooks

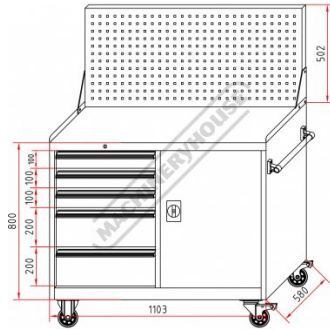

Diagram

Recommended Accessories

T786
 Steel Divider



T788
 Steel Divider



T786A
 Slotted Rail



T788A
 Slotted Rail

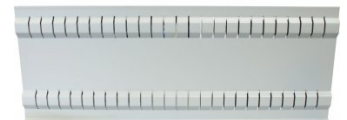

Product Brochure For T773

A439

Hook - Single Prong



A440

Hook - Single Prong

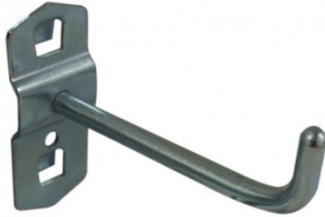

A4401

Hook - Single Prong

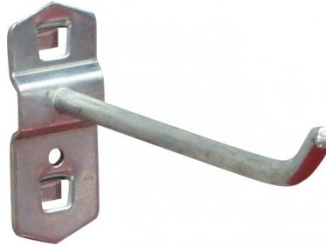

A441

Hook - Double Prong



A442

Hook - Double Prong



A4492

Hook - U Shape Holder



A449

Hook - U Shape Holder

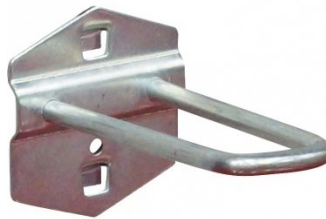

A4496

Round Tool Holder - Loop



A444

Plier Holder - Triple Prong



A446

Holder - Spanner



A448

Holder - Screwdriver



A427

Plastic Bucket



Product Brochure For T773

A428
 Plastic Bucket



A429
 Plastic Bucket



T703
 Magnetic Spray Can &
 Screwdriver Holder



H820
 Metric Hex Key Set with T-Bar
 Handle



H821
 Imperial Hex Key Set with T-Bar
 Handle



H822
 Torx® Key Set with T-Bar
 Handle



D1272
 Metric 135° Precision HSS Drill
 Set - 25 Piece



D1282
 Imperial 135° Precision HSS
 Drill Set - 29 Piece



D1285
 Metric 135° Precision HSS Drill
 Set - 51 Piece



D1071
 HSS Sheet Metal Step Drill Set -
 3 Piece



D1051
 HSS Countersink Set (90°
 Cross Hole Type) - 4 Piece



D1061
 HSS Countersink Set (90° 3
 Flute Type) - 6 Piece



Product Brochure For T773

D508

HSS Industrial Centre Drill Set – 5Pcs



D070

Drill Sharpener



H880

Dead Blow, Nylon Face Hammer



H870

Soft Face Hammer



H875

Soft Face Hammer - 5 piece



H885

Auto Panel Restoration Kit - DIY



H886

Auto Panel Restoration Kit - Professional



H887

Auto Panel Restoration Kit - Master



M988

Metric & Imperial Drill Gauge

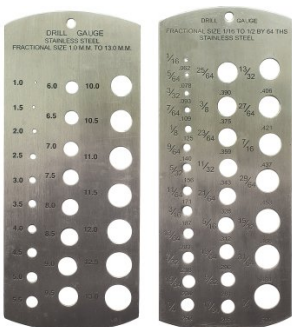

Q616

Feeler Gauge Set



T012

Metric Alloy Steel Tap & Die Set - 32 Piece



T013

Metric HSS Tap & Die Set - 32 Piece



Product Brochure For T773

T014
 Metric Alloy Steel Tap & Die Set
 - 45 Piece



T015
 Imperial Alloy Steel Tap & Die
 Set - 45 Piece



T016
 Metric HSS Tap & Die Set - 45
 Piece



T870
 Screw Extractor Set - 10 piece



T119
 Metric Thread Restorer File



T120
 Imperial Thread Restorer File



T100
 Metric Thread Repair Kit - 130
 Piece



T116
 Imperial Thread Restorer Tap &
 Die Kit - 26 Piece Set



T115
 Metric Thread Restorer Tap &
 Die Kit - 15 Piece



T117
 Metric, UNC, UNF Thread
 Restorer Tap & Die Kit - 48
 Piece



D108
 Metric Carbide Tipped Hole Saw
 Set



D102
 Metric HSS Hole Saw Set



Product Brochure For T773

F100
 Engineers Files, 5 Piece Set -
 Second Cut



F120
 Engineers File, Flat - Coarse
 Cut



F121
 Engineers File, Flat - Second
 Cut



F122
 Engineers File, Flat - Smooth
 Cut



F124
 Engineers File, Half Round -
 Coarse Cut



F125
 Engineers File, Half Round -
 Second Cut



F126
 Engineers File, Half Round -
 Smooth Cut



F127
 Engineers File, Round - Coarse
 Cut



F128
 Engineers File, Round - Second
 Cut



F129
 Engineers File, Round - Smooth
 Cut



F160
 Slapping File - Second Cut



F150
 Flexible Body File Holder



Product Brochure For T773

F155
Flexible Body File



F156
Flexible Body File



P112
Hole Punch Set



S203
180° Straight Edge/Seaming Plier



S205
90° Edge/Seaming Plier



S200
Joggler & Punch Plier



P368
Automatic Centre Punch



P367
Centre Punch Set - 3 Piece



P365
Pin Punch Set - 6 Piece



P363
Cold Chisel Set - 3 Piece



P364
Punch & Cold Chisel Set - 14 Piece



N001
Nut & Blind Riveter Set - 130 Piece



Product Brochure For T773

P350
Letter Punches



P351
Number Punches



P354
Letter Punches



P355
Number Punches



W103
Engineers Chalk Marker- 50
Splits



W104D
White Liquid Paint Marker -
Valve Action



W104B
Silver Streak - Welders Pencil



W104A
Orange Trades Marker Refills -
All Purpose



W104
Trades Marker - All Purpose



W104G
Silver Streak Refills - Round
Metal Marker



W104C
Silver Streak - Round Metal
Marker



D063
Sheet Metal Deburring Tool



Product Brochure For T773

D060
 Deburring Tool - Telescopic Shaft



D065
 Universal Deburring Tool Set - 23 Piece



D068
 Pipe/Tube Deburring Tool - Internal / External



B900
 Carbide Burr Double Cut Set - Short Series



B905
 Carbide Burr Double Cut Set - Long Series



M0010
 Pick Up Tool with Magnetic Head & 1 x LED Light

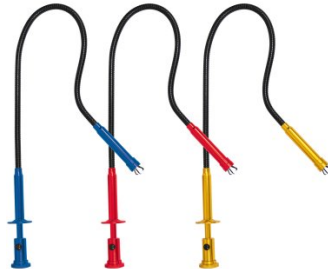

M0009
 Magnetic Pick Up Tool & Inspection Mirror Set



L300
 Magnetic Swarf Remover



P020
 Hydraulic Chassis Punch Set



W112
 Micro Welding Steel Clamp Set



W113
 Butt Welding Aluminium & Steel Clamp Set



S077
 Drilling, Tapping & Cutting Tool Lubricant Spray - 400g



Product Brochure For T773

S075

Cutting Tool Lubricant Paste - 200g



O043

Rust & Corrosion Preventive



O042

General Purpose Lubricant & Corrosion Inhibitor



O040

Rust & Corrosion Preventive



O044

Rust & Corrosion Preventive



P030

Bush Driver Set - 17 piece



P031

Bearing Race & Seal Driver Set - 10 piece



P005

Ratcheting Gear Puller Set



P013

Puller Set with Slide Hammer



P011

Hydraulic Gear Puller Kit



A037

Air Tool Oil



G076

Top Up Pump



Product Brochure For T773

G077
 Oil Transfer Pump



G065
 Suction Gun - Oil Transfer



G070
 Grease Gun



G072
 Grease Gun



G063
 Grease Gun



G074
 Air Operated Grease Gun



G066
 Air Operated Power Pistol - Grease Gun



G060
 Grease Gun



G067
 Lithium-ion Battery Operated - Grease Gun



G057
 Super Blue Complex Grease Cartridge



O002
 Superdrdraulic ISO 46 Hi Temp Hydraulic Oil

