

Product Brochure For Q323

Metric Outside Micrometer - Large Cast Frame - 12-323

250 - 275mm Range



ORDER CODE:	Q323
Range (mm):	250 - 275
Graduation (mm):	0.01
Accuracy (mm):	0.009
Setting Bar (No.):	1
a (mm):	19.4
b (mm):	5.5
c (mm):	155
L (mm):	285
m061:	~

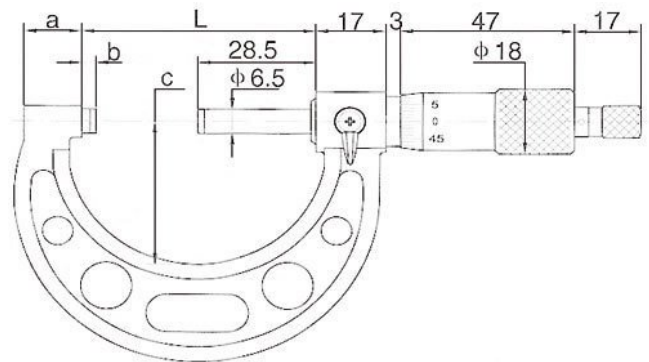

Description

Measumax metric micrometers represent exceptional value. Special care has been taken in design and workmanship to ensure high precision and long life. Measumax metric micrometers meet industry standards for specification and accuracy

Features

- Carbide measuring faces - Painted cast frame
- Micro-fine clear graduations on satin chrome finish
- Measuring face 6.5mm, Flatness 0.0008mm
- Ratchet stop for exact repetitive readings
- Includes deluxe foam lined plastic case and wrench
- Graduation 0.01mm
- Supplied with setting standards