

Product Brochure For P729

**Ø29mm Round Punch - RPN1**

Hi -Grade Tool Steel Imported From Japan

**Ex GST**  
**\$50.00**

**Inc GST**  
**\$55.00**



ORDER CODE:	P729
MODEL:	RPN1
Type:	Punch
Punch Diameter (D) (mm):	Ø29
Die Diameter (D) (mm):	~
Pack Quantity (No.):	1



**Description**

Punch and Dies are Manufactured by Sunrise in Taiwan using Hi -Grade Tool Steel imported from Japan. The manufacturing process involves machining via hi tech CNC machines lathes & mills, vacuum heat treatment with multiple tempering at high temperatures before a final quality inspection/testing process all of which ensures an accurate, precise, durable & stable product.

**Features**

- PLEASE NOTE FOLLOWING RECOMMENDATIONS WHEN SELECTING DIE CLEARANCE:
- Material Thickness - 2 ~ 4mm = Die Clearance 0.2mm
- Material Thickness - 4 ~ 9.5mm = Die Clearance 0.7mm
- Material Thickness - 10 ~ 14.5mm = Die Clearance 1.2mm
- Material Thickness - 15 ~ 19.5mm = Die Clearance 1.7mm
- Material Thickness - 20 ~ 24mm = Die Clearance 2.2mm

**Optional Accessories**

- Other sizes and shapes available on request

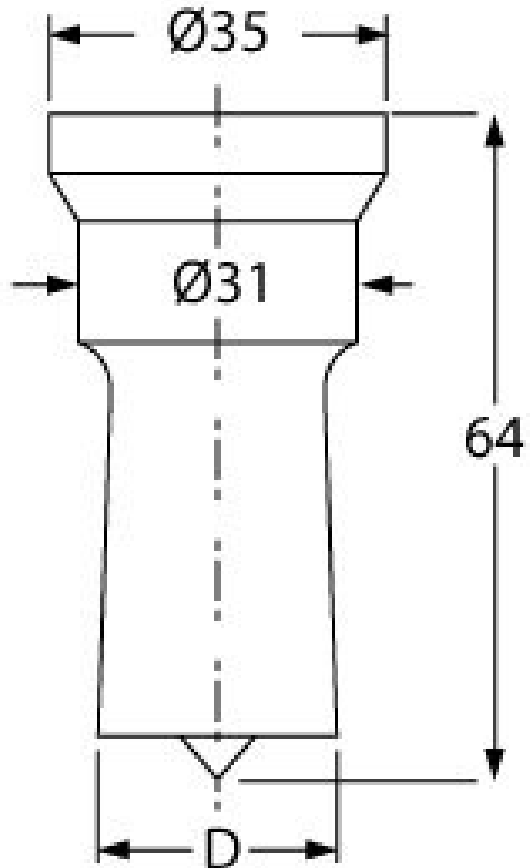

Product Brochure For P729

---

**Recommended Accessories**

P729B

Ø29.2mm Round Die - RDN1

P729A

Ø29.7mm Round Die - RDN1

P730B

Ø30.2mm Round Die - RDN1

P730A

Ø30.7mm Round Die - RDN1



P731B

Ø31.2mm Round Die - RDN1

P731A

Ø31.7mm Round Die - RDN1

