

Product Brochure For M165

NT30-MT2-50 Milling Adaptor

<b>Ex GST</b>	<b>Inc GST</b>
<b>\$70.00</b>	<b>\$77.00</b>

ORDER CODE:	M165
MODEL:	NT30-MT2-50
Outer Taper:	NT30
Inside Taper:	MT2
Drawbar Thread (mm / inch):	12mm
L (mm):	50
C (mm):	32
Nett Weight (kg):	0.80

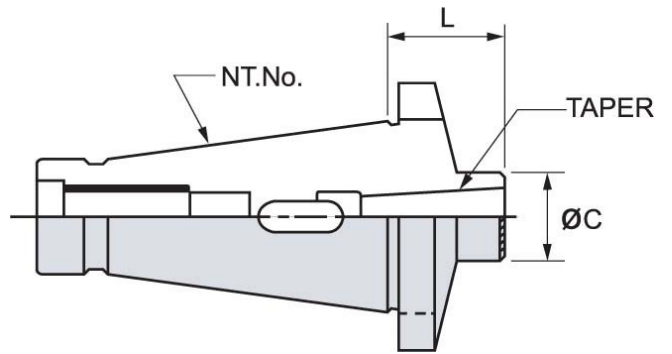

**Description**

Precision ground and hardened.  
 Morse taper adaptors are used to adapt a Morse taper tool or cutter to any spindle taper