

Product Brochure For H354

## 16mm 3.2T Grade S - Lifting Bow Shackle - GSSB16

Galvanised Finish With Yellow Pin

"Grade S" - Compliant & Meets The Requirement of AS2741

Ex GST

\$9.00

Inc GST

\$9.90



Order Code:	H354
Model:	GSSB16
W.L.L - Working Load Limit (Tonne):	3.2
Body Diameter (mm):	16
A - Throat Opening (mm):	27
B - Pin Diameter (mm):	19
C - Throat Depth (mm):	52

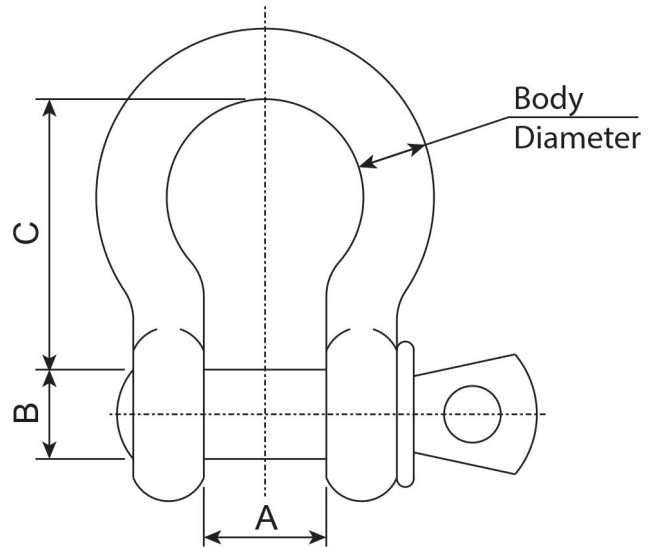

### Description

- The most common shackles used in lifting applications, with a high strength to size ratio
- Easy and effective way of providing a connection of slings, chains and wire ropes
- Supplied in a galvanised finish with yellow painted pin
- Suitable applications: Marine, agricultural, towing, & general industrial
- Compliant & meets the requirement of AS 2741

### Features

- 3.2 Tonne working load limit
- 16mm Body Diameter
- 52mm Throat depth
- 27mm Throat opening
- 19mm Pin diameter