

Product Brochure For G610

Lathe Safety Chuck Guard - LG-7

178mm Centre Height

Ex GST
\$180.00

Inc GST
\$198.00



ORDER CODE:	G610
MODEL:	LG-7
Guard Type:	Safety Chuck Guard
Material Type:	Steel
Leadscrew Cover Width (mm):	~
Suits Lathe - Distance Between Centres (mm):	~
Suits Lathe Centre Height (mm):	178
Suits Lathe Chuck Size Max. (mm):	Ø200



Features

- Retro fits to lathe headstock with a 178mm centre height
- Suits up to Ø200mm lathe chucks
- Swivel steel safety chuck guard with handle
- Includes safety chuck guard, mounting bracket with micro switch and wiring
- Micro switch recommended for 12V or 24V
- Installation required by a licensed electrician

Product Brochure For G610

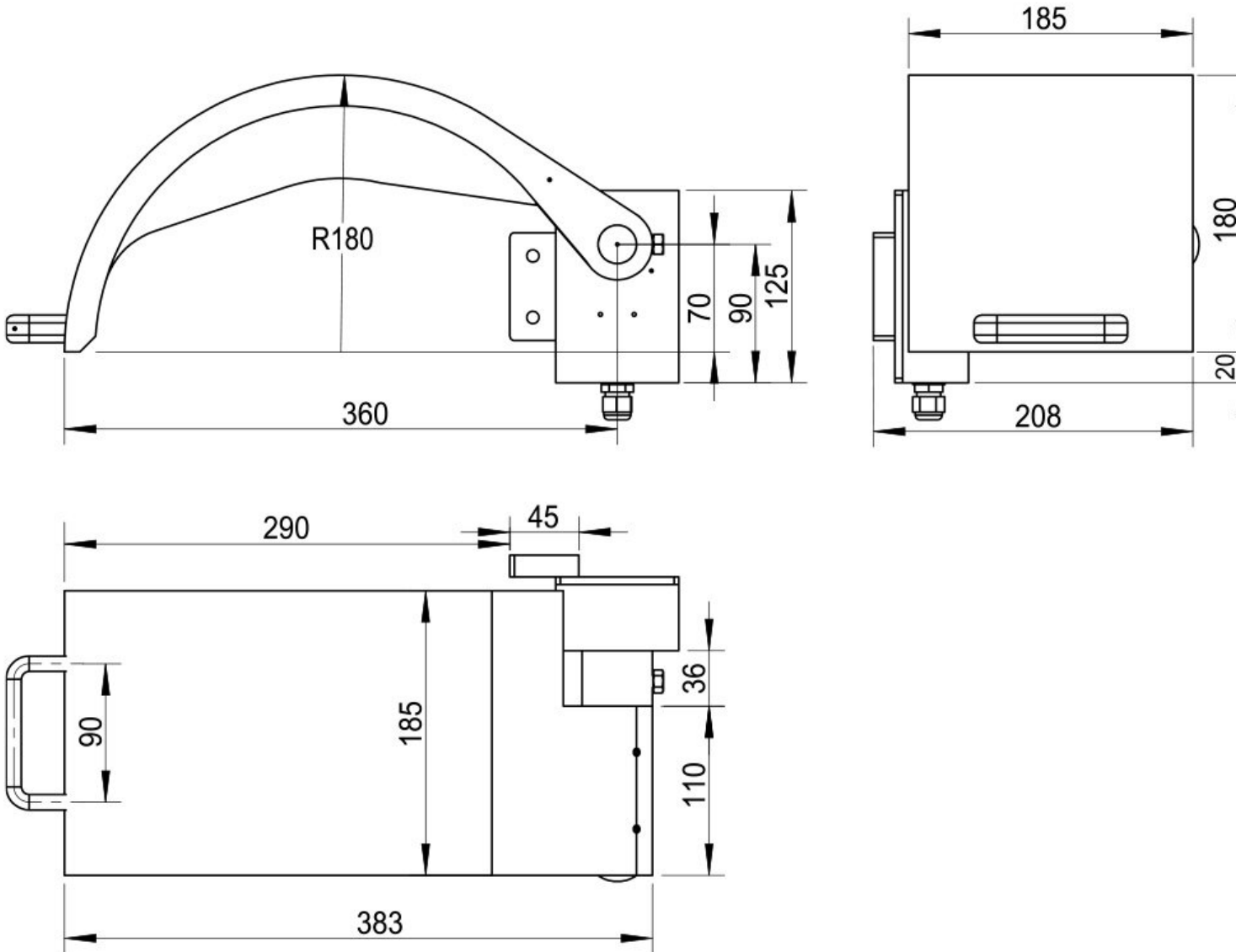

Product Brochure For G610

Specific Features

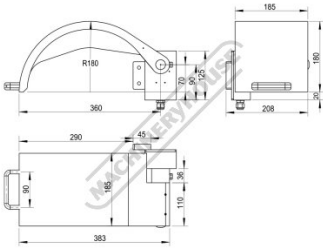

Dimensions