

Product Brochure For C8005

# CNC Lathe - Tee Nut Sets Type B

Suit Size 10

**Ex GST**  
**\$150.00**

**Inc GST**  
**\$165.00**



ORDER CODE:	C8005
Type:	Type B
Suit Size (mm):	10
H (mm):	25.5
h1 (mm):	16
h2 (mm):	9.5
B (mm):	22.5
L (mm):	55
G (mm):	11
CHD (mm):	30
S (mm):	16
Cap Screw (mm):	M12

**CHUCK JAWS T-NUTS  
 HARDENED AND GROUND**

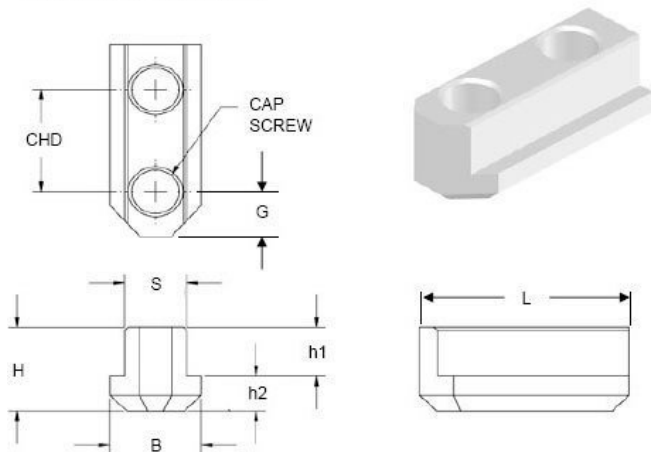

## Description

Suits Kitagawa Chucks