

Product Brochure For P722

Ø22mm Round Punch - RPN1

Hi -Grade Tool Steel Imported From Japan

Ex GST
 \$50.00

Inc GST
 \$55.00



ORDER CODE:	P722
MODEL:	RPN1
Type:	Punch
Punch Diameter (D) (mm):	Ø22
Die Diameter (D) (mm):	~
Pack Quantity (No.):	1

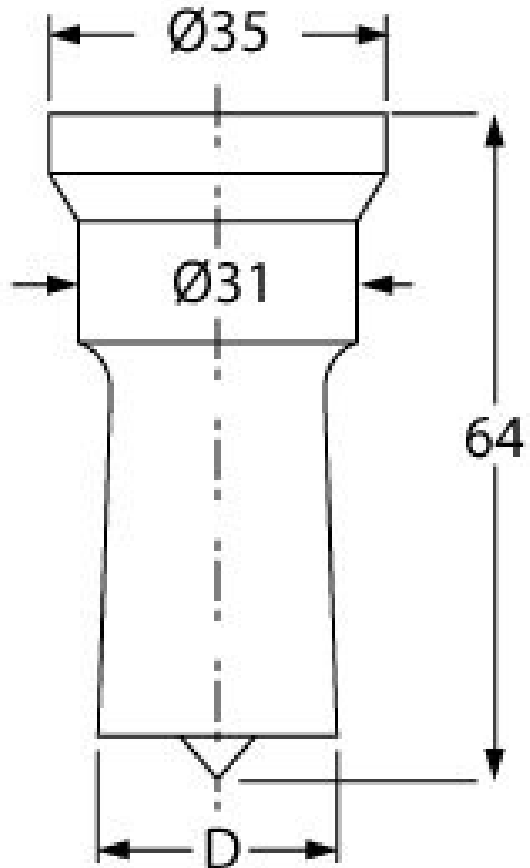

Description

Punch and Dies are Manufactured by Sunrise in Taiwan using Hi -Grade Tool Steel imported from Japan. The manufacturing process involves machining via hi tech CNC machines lathes & mills, vacuum heat treatment with multiple tempering at high temperatures before a final quality inspection/testing process all of which ensures an accurate, precise, durable & stable product.

Features

- PLEASE NOTE FOLLOWING RECOMMENDATIONS WHEN SELECTING DIE CLEARANCE:
- Material Thickness - 2 ~ 4mm = Die Clearance 0.2mm
- Material Thickness - 4 ~ 9.5mm = Die Clearance 0.7mm
- Material Thickness - 10 ~ 14.5mm = Die Clearance 1.2mm
- Material Thickness - 15 ~ 19.5mm = Die Clearance 1.7mm
- Material Thickness - 20 ~ 24mm = Die Clearance 2.2mm

Optional Accessories

- Other sizes and shapes available on request

Product Brochure For P722

Recommended Accessories

P722B

Ø22.2mm Round Die - RDN1

P722A

Ø22.7mm Round Die - RDN1

P723B

Ø23.2mm Round Die - RDN1

P723A

Ø23.7mm Round Die - RDN1



P724B

Ø24.2mm Round Die - RDN1

